

COMMODORE CLASS - CHASSIS MOUNT WITH QUICK-CONNECT TERMINALS POWER TRANSFORMER

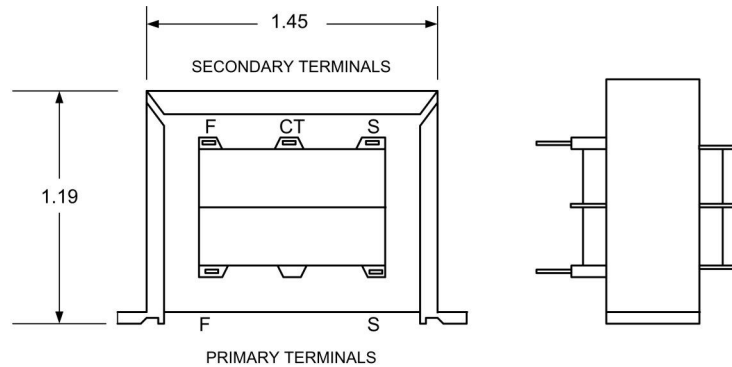

0.187" QUICK-CONNECT OR SOLDER LUG TERMINALS

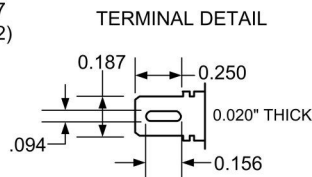
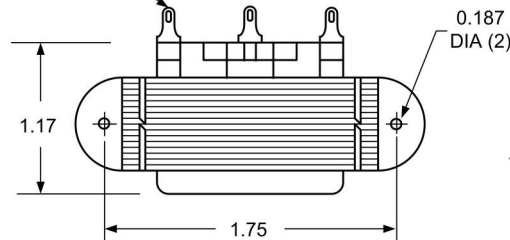

1. Electrical Specifications
 - A. Maximum Power: 2.4VA
 - B. Input Voltage and Frequency: 115V, 230V 50/60Hz
 - C. Voltage Regulation: 18% TYP @ full load to no load
 - D. Temperature Rise: 20°C TYP
 - E. Insulation Resistance: < 1 MEG ohm
 - F. Hi-Pot: 2500Vrms 1 minute
2. Marking: Ensign Corp, part number (see table), date code, country, terminal number
3. Agency Approval:
 - UL/cUL 5085-2 Recognized (File 47299)
 - UL 1446 Recognized Insulation System (File 95662)
 - UL/cUL 5085-3 Class 2 Recognized (File E43609)

Class 2   

Primary Schematics

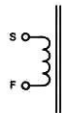

Single Input
(Specify 115V,
120V, 230V or
240V)

Secondary Schematics

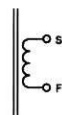

Single Output

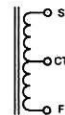

Center-Tapped Output

Part Number			
115V	115/230V	230V	Secondary
T002-1-710X	T002-2-710X	T002-3-710X	10VCT @ 250mA
T002-1-712X	T002-2-712X	T002-3-712X	12.6VCT @ 200mA
T002-1-716X	T002-2-716X	T002-3-716X	16VCT @ 150mA
T002-1-720X	T002-2-720X	T002-3-720X	20VCT @ 120mA
T002-1-724X	T002-2-724X	T002-3-724X	24VCT @ 100mA

 THE FLAGSHIP OF CUSTOM MAGNETICS SINCE 1939	POWER TRANSFORMER COMMODORE CLASS		T002-1-XXXX T002-2-XXXX T002-3-XXXX	
	CONTENTS OF THIS DRAWING ARE SUBJECT TO CHANGE WITHOUT PRIOR NOTICE	Ensign Corporation 201 ENSIGN RD., BELLEVUE, IA 52031		Dim: Inches
PROPRIETARY NOTICE: THIS DRAWING PRINT OR DOCUMENT AND SUBJECT MATTER DISCLOSED HEREIN ARE PROPRIETARY ITEMS TO WHICH ENSIGN RETAINS THE EXCLUSIVE RIGHT OF DISSEMINATION, MANUFACTURE AND SALE. THIS DRAWING, PRINT OR DOCUMENT IS SUBMITTED IN CONFIDENCE FOR CONSIDERATION BY THE RECIPIENT ALONE UNLESS PERMISSION FOR FURTHER DISCLOSURE IS EXPRESSLY GRANTED IN WRITING				